



IGBT Modules

V_{CEs}	1200V
I_C	100A

Applications

- Motor Drivers
- AC and DC servo drive amplifier
- UPS (Uninterruptible Power Supplies)

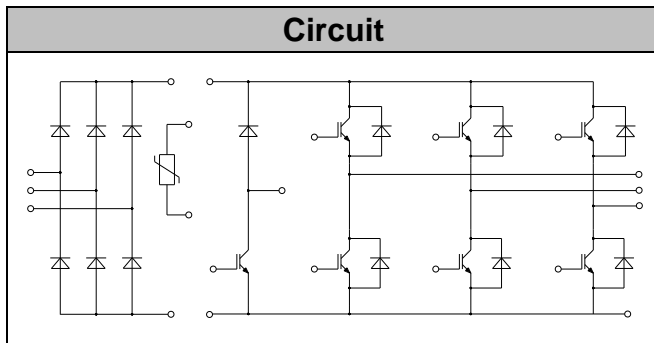

Features

- Low $V_{ce(sat)}$ with Planner technology
- Low $V_{ce(sat)}$ with positive temperature coefficient
- Including fast & soft recovery anti-parallel FWD
- Low inductance case
- High short circuit capability(10us)
- Maximum junction temperature 175°C

● IGBT- inverter

Absolute Maximum Ratings

Parameter	Symbol	Conditions	Value	Unit
Collector-Emitter Voltage	V_{CES}	$V_{GE}=0V, I_C=1mA, T_{vj}=25^{\circ}C$	1200	V
Continuous Collector Current	I_C	$T_c=80^{\circ}C, T_{vjmax}=150^{\circ}C$	100	A
Repetitive Peak Collector Current	I_{CRM}	$t_p=1ms$	200	A
Gate-Emitter Voltage	V_{GES}	$T_{vj}=25^{\circ}C$	± 20	V
Total Power Dissipation	P_{tot}	$T_c=25^{\circ}C, T_{vjmax}=175^{\circ}C$	625	W



Characteristic values

Parameter	Symbol	Conditions	Value			Unit	
			Min.	Typ.	Max.		
Gate-Emitter Threshold Voltage	$V_{GE(th)}$	$V_{GE}=V_{CE}, I_C=4mA, T_{vj}=25^{\circ}C$	5.0	5.8	6.5	V	
Collector-Emitter Cut-off Current	I_{CES}	$V_{CE}=1200V, V_{GE}=0V, T_{vj}=25^{\circ}C$			1.0	mA	
		$V_{CE}=1200V, V_{GE}=0V, T_{vj}=125^{\circ}C$			5.0	mA	
Collector-Emitter Saturation Voltage	$V_{CE(sat)}$	$I_C=100A, V_{GE}=15V, T_{vj}=25^{\circ}C$		1.95	2.25	V	
		$I_C=100A, V_{GE}=15V, T_{vj}=125^{\circ}C$		2.15			
Input Capacitance	C_{ies}	$V_{CE}=25V, V_{GE}=0V, f=1MHz, T_{vj}=25^{\circ}C$		5.80		nF	
Output Capacitance	C_{oes}			0.60		nF	
Reverse Transfer Capacitance	C_{res}			0.40		nF	
Internal Gate Resistance	R_{gint}			2.5		Ω	
Gate-Emitter leakage current	I_{GES}	$V_{CE}=0V, V_{GE}=20V, T_{vj}=25^{\circ}C$			400	nA	
Turn-on Delay Time	$t_{d(on)}$	$I_C=100A, V_{CE}=600V, V_{GE}=\pm 15V, R_G=5.1\Omega, T_{vj}=25^{\circ}C$		240		ns	
Rise Time	t_r			55		ns	
Turn-off Delay Time	$t_{d(off)}$			395		ns	
Fall Time	t_f			178		ns	
Energy Dissipation During Turn-on Time	E_{on}			4.1		mJ	
Energy Dissipation During Turn-off Time	E_{off}			7.3		mJ	
Turn-on Delay Time	$t_{d(on)}$		$I_C=150A, V_{CE}=600V, V_{GE}=\pm 15V, R_G=5.1\Omega, T_{vj}=125^{\circ}C$		260		ns
Rise Time	t_r				68		ns
Turn-off Delay Time	$t_{d(off)}$				420		ns
Fall Time	t_f				280		ns
Energy Dissipation During Turn-on Time	E_{on}			5.3		mJ	
Energy Dissipation During Turn-off Time	E_{off}			9.1		mJ	
SC Data	I_{sc}	$T_p \leq 10\mu s, V_{GE}=15V, T_{vj}=150^{\circ}C, V_{cc}=600V, V_{CEM} \leq 1200V$		700		A	



● Diode-inverter

Absolute Maximum Ratings

Parameter	Symbol	Conditions	Value	Unit
Repetitive Peak Reverse Voltage	V_{RRM}	$T_{vj}=25^{\circ}C$	1200	V
Continuous DC Forward Current	I_F		100	A
Repetitive Peak Forward Current	I_{FRM}	$t_p=1ms$	200	A

Characteristic values

Parameter	Symbol	Conditions	Value			Unit	
			Min.	Typ.	Max.		
Forward Voltage	V_F	$I_F=100A, T_{vj}=25^{\circ}C$		1.80	2.00	V	
		$I_F=100A, T_{vj}=125^{\circ}C$		1.85			
Recovered Charge	Q_{rr}	$I_F = 100 A$ $V_R=600V$ $-di_F/dt = 2300A/us$ $T_{vj}=25^{\circ}C$		4.5		μC	
Peak Reverse Recovery Current	I_{rr}			80		A	
Reverse Recovery Time	t_{rr}			85		ns	
Reverse Recovery Energy	E_{rec}			2.5		mJ	
Recovered Charge	Q_{rr}		$I_F = 100 A$ $V_R=600V$		9.2		μC
Peak Reverse Recovery Current	I_{rr}		$-di_F/dt = 2300A/us$ $T_{vj}=125^{\circ}C$		95		A



● IGBT-brake-chopper

Absolute Maximum Ratings

Parameter	Symbol	Conditions	Value	Unit
Collector-Emitter Voltage	V_{CES}	$V_{GE}=0V, I_c=1mA, T_{vj}=25^{\circ}C$	1200	V
Continuous Collector Current	I_c	$T_c=80^{\circ}C, T_{vjmax}=150^{\circ}C$	50	A
Repetitive Peak Collector Current	I_{CRM}	$t_p=1ms$	100	A
Gate-Emitter Voltage	V_{GES}	$T_{vj}=25^{\circ}C$	± 20	V
Total Power Dissipation	P_{tot}	$T_c=25^{\circ}C, T_{vjmax}=150^{\circ}C$	222	W

Characteristic values

Parameter	Symbol	Conditions	Value			Unit
			Min.	Typ.	Max.	
Gate-Emitter Threshold Voltage	$V_{GE(th)}$	$V_{GE}=V_{CE}, I_c=1.2mA, T_{vj}=25^{\circ}C$	5.0	6.2	7.0	V
Collector-Emitter Cut-off Current	I_{CES}	$V_{CE}=1200V, V_{GE}=0V, T_{vj}=25^{\circ}C$			1.0	mA
Collector-Emitter Saturation Voltage	$V_{CE(sat)}$	$I_c=50A, V_{GE}=15V, T_{vj}=25^{\circ}C$		1.85	2.35	V
		$I_c=50A, V_{GE}=15V, T_{vj}=125^{\circ}C$		2.05		
		$I_c=50A, V_{GE}=15V, T_{vj}=150^{\circ}C$		2.10		
Gate Charge	Q_G			0.54		uC
Input Capacitance	C_{ies}	$V_{CE}=25V, V_{GE}=0V, f=1MHz, T_{vj}=25^{\circ}C$		4.30		nF
Reverse Transfer Capacitance	C_{res}			0.20		nF
Gate-Emitter leakage current	I_{GES}	$V_{CE}=0V, V_{GE}=20V, T_{vj}=25^{\circ}C$			400	nA
Turn-on Delay Time	$t_{d(on)}$	$I_c=50A$ $V_{CE}=600V$ $V_{GE}=\pm 15V$ $R_G=15\Omega$ $T_{vj}=25^{\circ}C$		390		ns
Rise Time	t_r			75		ns
Turn-off Delay Time	$t_{d(off)}$			384		ns
Fall Time	t_f			86		ns
Energy Dissipation During Turn-on Time	E_{on}			6.3		mJ
Energy Dissipation During Turn-off Time	E_{off}			3.2		mJ



Turn-on Delay Time	$t_{d(on)}$	$I_C = 50\text{ A}$ $V_{CE} = 600\text{ V}$ $V_{GE} = \pm 15\text{ V}$ $R_G = 15\Omega$ $T_{vj} = 125^\circ\text{C}$	410	ns
Rise Time	t_r		76	ns
Turn-off Delay Time	$t_{d(off)}$		410	ns
Fall Time	t_f		95	ns
Energy Dissipation During Turn-on Time	E_{on}		7.3	mJ
Energy Dissipation During Turn-off Time	E_{off}		5.7	mJ
SC Data	I_{sc}		$T_p \leq 10\mu\text{s}, V_{GE} = 15\text{ V}, T_{vj} = 150^\circ\text{C},$ $V_{cc} = 900\text{ V}, V_{CEM} \leq 1200\text{ V}$	274

● Diode-Brake-Chopper

Absolute Maximum Ratings

Parameter	Symbol	Conditions	Value	Unit
Repetitive Peak Reverse Voltage	V_{RRM}	$T_j = 25^\circ\text{C}$	1200	V
Continuous DC Forward Current	I_F		50	A
Repetitive Peak Forward Current	I_{FRM}	$t_p = 1\text{ ms}$	100	A
I^2t -value	I^2t	$V_R = 0, t_p = 10\text{ ms}, T_j = 125^\circ\text{C}$	1550	A ² s
		$V_R = 0, t_p = 10\text{ ms}, T_j = 150^\circ\text{C}$	1500	

Characteristic values

Parameter	Symbol	Conditions	Value			Unit
			Min.	Typ.	Max.	
Forward Voltage	V_F	$I_F = 50\text{ A}, T_{vj} = 25^\circ\text{C}$		1.95	2.25	V
		$I_F = 50\text{ A}, T_{vj} = 125^\circ\text{C}$		2.05		
		$I_F = 50\text{ A}, T_{vj} = 150^\circ\text{C}$		2.10		
Recovered Charge	Q_{rr}	$I_F = 50\text{ A}$		3.5		μC
Peak Reverse Recovery Current	I_{rr}	$V_R = 600\text{ V}$ $-di_F/dt = 900\text{ A}/\mu\text{s}$		40		A
Reverse Recovery Energy	E_{rec}	$T_{vj} = 25^\circ\text{C}$		1.4		mJ



Recovered Charge	Q_{rr}	$I_F = 50\text{ A}$	6.5	uC
Peak Reverse Recovery Current	I_{rr}	$V_R = 600\text{ V}$ $-di_F/dt = 900\text{ A/us}$	50	A
Reverse Recovery Energy	E_{rec}	$T_{vj} = 125^\circ\text{ C}$	2.0	mJ

● Diode-Rectifier

Absolute Maximum Ratings

Parameter	Symbol	Conditions	Value	Unit
Repetitive Peak Reverse Voltage	V_{RRM}	$T_j = 25^\circ\text{ C}$	1600	V
Average On-state Current 50/60Hz, sine wave	$I_{F(AV)}$	$T_c = 80^\circ\text{ C}$	100	A
Maximum RMS Current at Rectifier Output	I_{RMSM}	$T_c = 80^\circ\text{ C}$	150	A
Surge Forward Current	I_{FSM}	$V_R = 0, t_p = 10\text{ ms}, T_j = 25^\circ\text{ C}$	1150	A
I^2t -value	I^2t	$V_R = 0, t_p = 10\text{ ms}, T_j = 25^\circ\text{ C}$	6600	A^2s

Characteristic values

Parameter	Symbol	Conditions	Value			Unit
			Min.	Typ.	Max.	
Diode Forward Voltage	V_F	$I_F = 100\text{ A}, T_j = 150^\circ\text{ C}$		1.0		V
Reverse Current	I_R	$T_j = 125^\circ\text{ C}, V_R = 1600\text{ V}$			2.0	mA

● NTC-Thermistor

Characteristic values

Parameter	Symbol	Conditions	Value			Unit
			Min.	Typ.	Max.	
Rated Resistance	R_{25}			5.0		$\text{k}\Omega$
Deviation of R_{100}	$\Delta R/R$	$T_C = 100, R_{100} = 493.3\ \Omega$	-5		5	%
Power Dissipation	P_{25}			20.0		mW
B-value	$B_{25/50}$	$R_2 = R_{25} \exp[B_{25/50}(1/T_2 - 1/(298.15\text{K}))]$		3375		K



● **Module Characteristics** $T_c=25^\circ\text{C}$ unless otherwise specified

Parameter	Symbol	Conditions	Value			Unit
			Min.	Typ.	Max.	
Isolation voltage	V_{isol}	$t=1\text{min}, f=50\text{Hz}$	2500			V
Maximum Junction Temperature	T_{jmax}	Inverter, brake			150	$^\circ\text{C}$
		rectifier			125	
Operating Junction Temperature	$T_{vj\text{op}}$		-40		125	$^\circ\text{C}$
Storage Temperature	T_{stg}		-40		125	$^\circ\text{C}$
Stray Inductance	L_{CE}			40		nH
Module Lead Resistance ,Terminal to Chip	$R_{cc'+EE'}$	$T_c=25^\circ\text{C}$, per switch		4.0		m Ω
	$R_{AA'+CC'}$			3.0		
Thermal Resistance Junction-to Case	$R_{\theta jc}$	per IGBT-inverter			0.200	K/W
		per Diode-inverter			0.360	
		per IGBT-brake-copper			0.321	
		per Diode-chopper			0.563	
		per Diode-rectifier			0.318	
Thermal Resistance Case-to Sink	$R_{\theta cs}$	per IGBT-inverter		0.104		K/W
		per Diode-inverter		0.190		
		per IGBT-brake-copper		0.177		
		per Diode-chopper		0.310		
		per Diode-rectifier		0.175		
		per Module		0.009		
Module-to-Sink Torque	M_s		3.0		6.0	N·m
Weight of Module	G			300		g

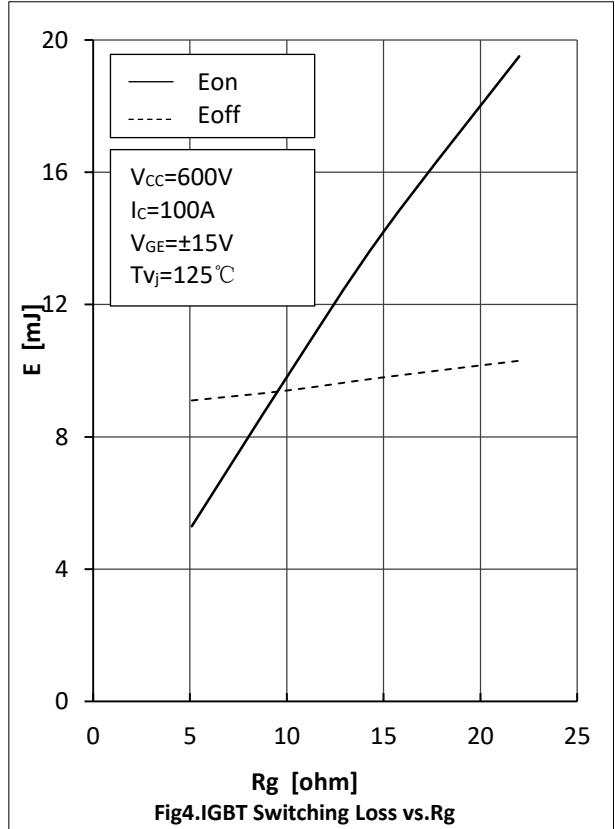
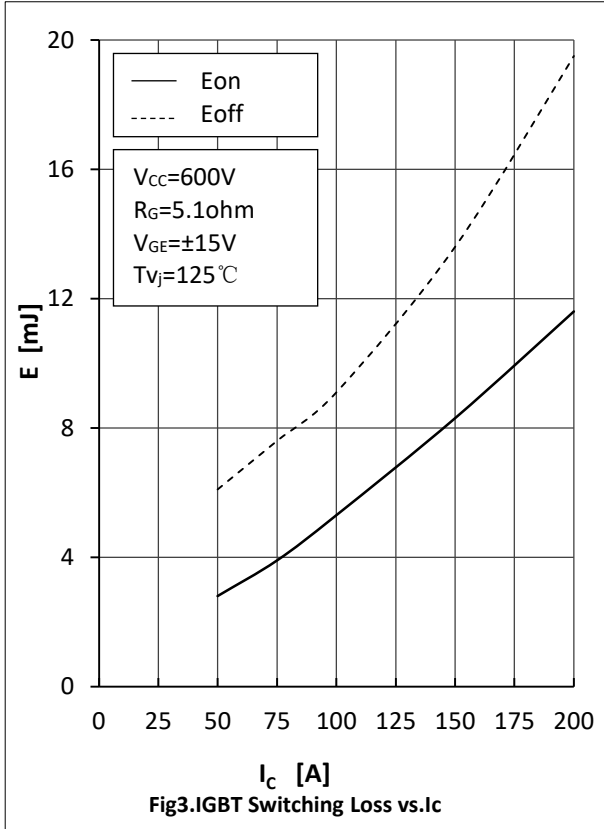
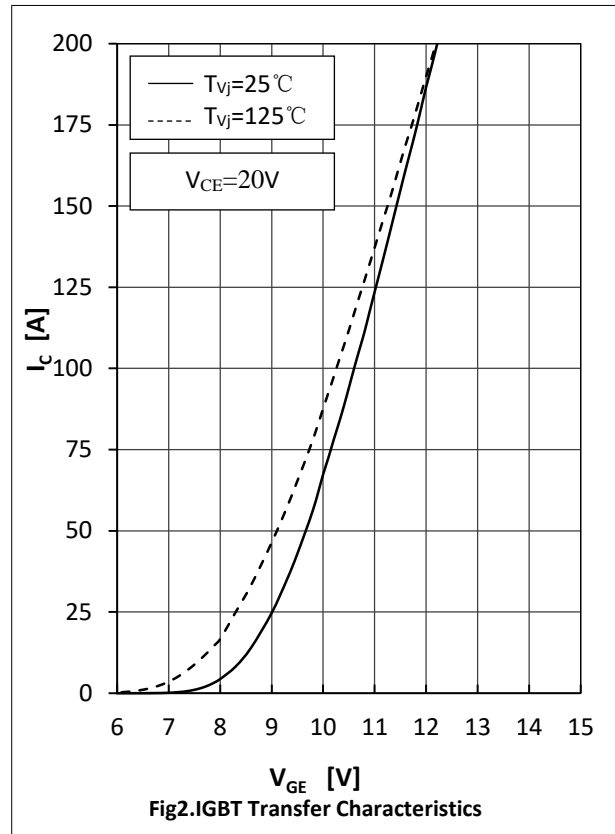
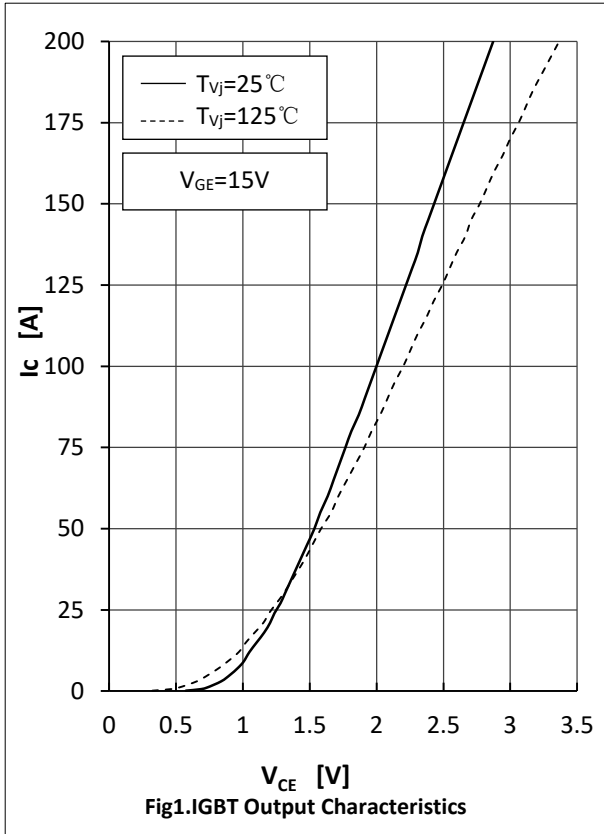

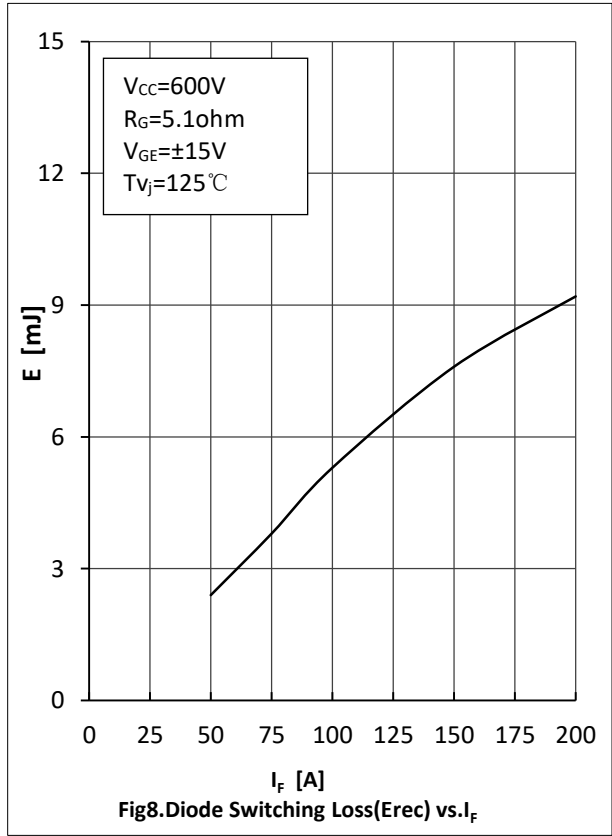
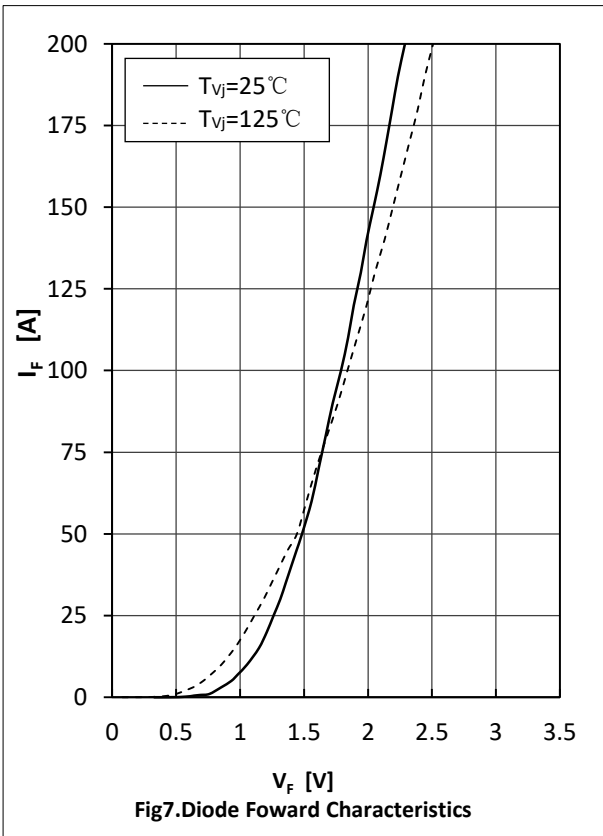
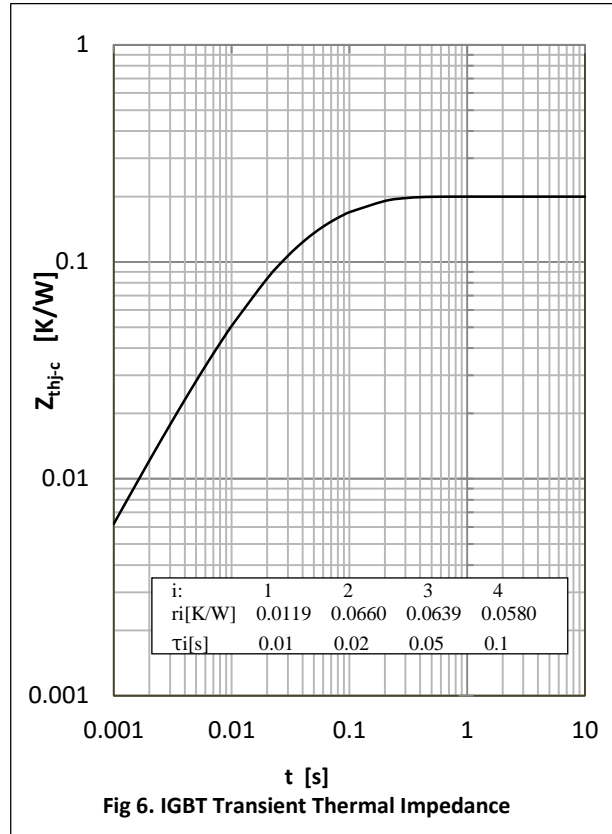
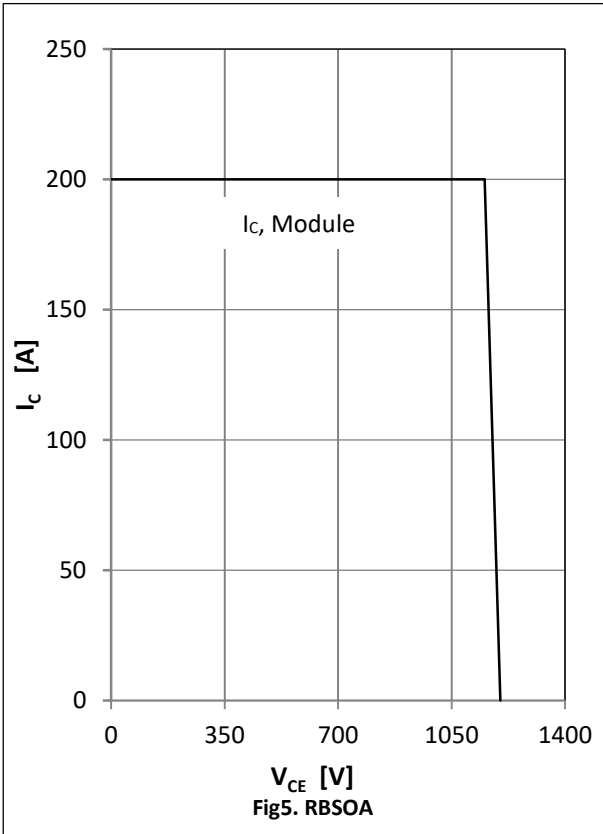

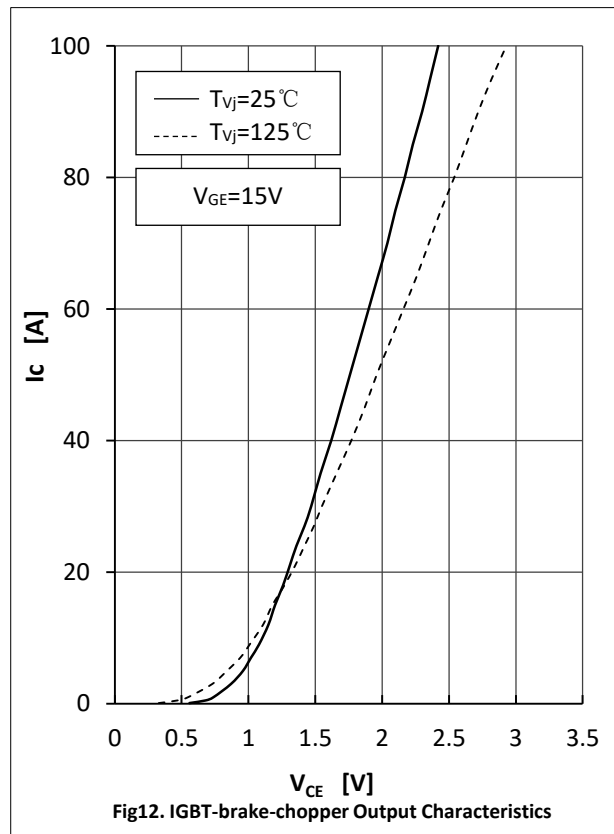
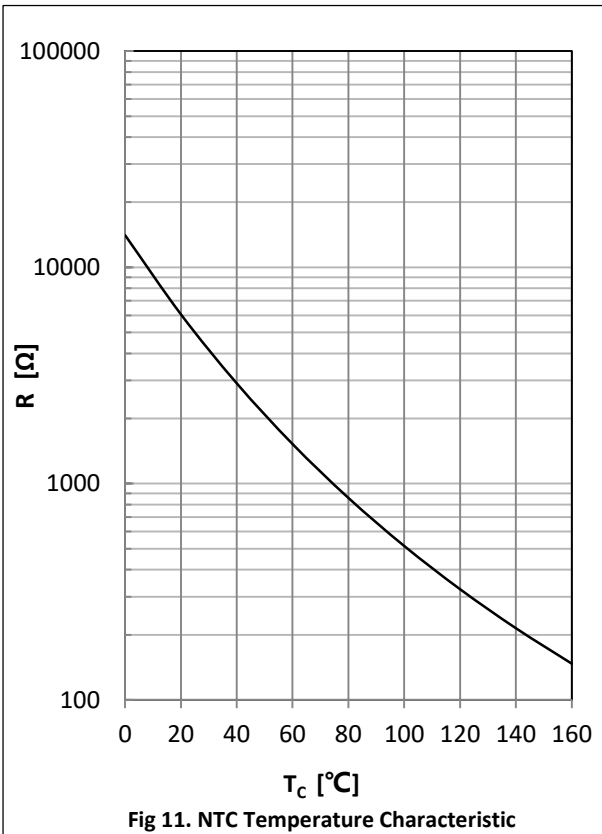
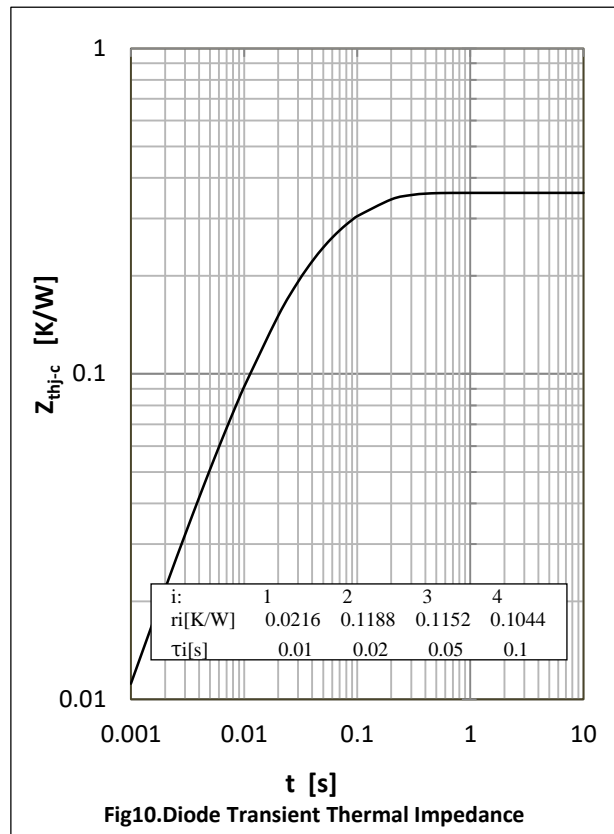
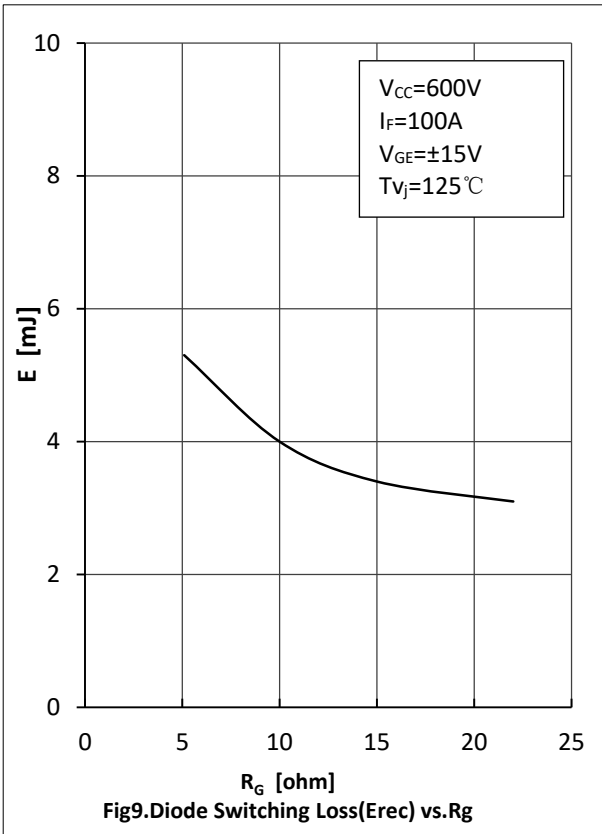

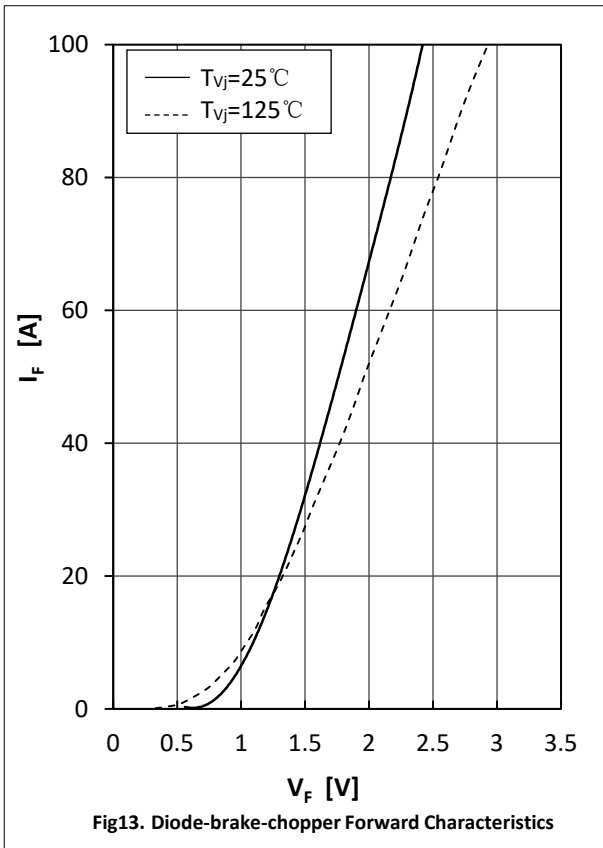



● **Circuit Diagram**

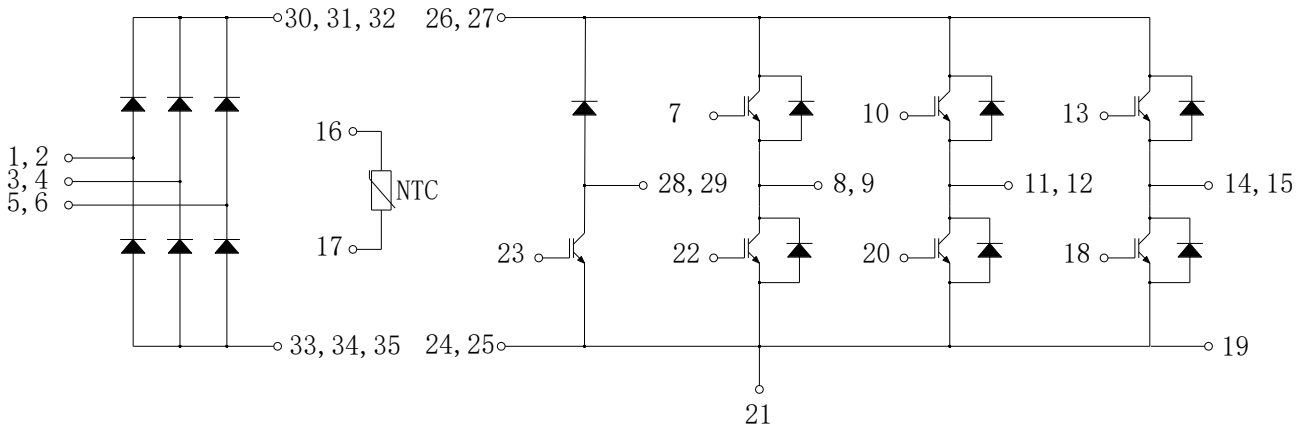

● **Package Dimensions**

