

IGBT Discrete

V_{CE}	1200	V
I_C	80	A
$V_{CE(SAT)} I_C=80A$	1.75	V
P_D	735	W

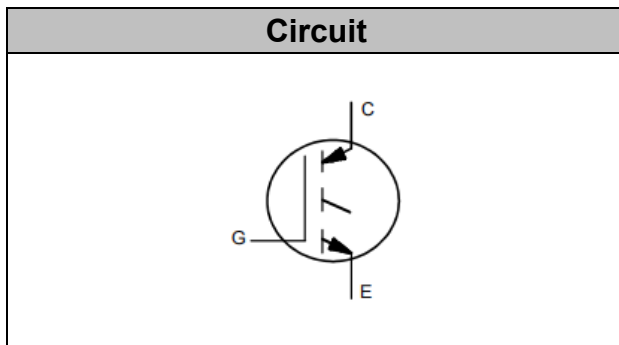

Applications

- PTC heater

Features

- High breakdown voltage to 1200V for improved reliability
- Maximum junction temperature 150°C
- Positive temperature coefficient
- Qualified to AEC-Q101

Maximum Ratings

Parameter	Symbol	Value	Unit
Collector-Emitter Breakdown Voltage	V_{CE}	1200	V
DC Collector Current, limited by T_{jmax} $T_C=25^\circ C$ $T_C=100^\circ C$	I_C	145* 80	A
Continuous Gate-Emitter Voltage	V_{GE}	± 20	V
Transient Gate-Emitter Voltage ($t_p \leq 10\mu s, D < 0.010$)	V_{GE}	± 30	V
Turn off Safe Operating Area $V_{CE} \leq 1200V$, $T_j \leq 150^\circ C$		240	A
Pulsed Collector Current, $V_{GE}=15V$, t_p limited by T_{jmax}	I_{CM}	240	A
Power Dissipation, $T_j=150^\circ C$, $T_C=25^\circ C$	P_{tot}	735	W

*Bond wire current limit is 80A



Operating Junction Temperature	T_j	-40...+150	°C
Storage Temperature	T_s	-55...+150	°C
Soldering Temperature, wave soldering 1.6mm (0.063in.) from case for 10s		260	°C

Electrical Characteristics of the IGBT ($T_j = 25^\circ\text{C}$ unless otherwise specified):

Parameter	Symbol	Conditions	Min.	Typ.	Max.	Unit
Static						
Collector-Emitter Breakdown Voltage	BV_{CES}	$V_{GE}=0V, I_C=250\mu A$	1200		-	V
Gate Threshold Voltage	$V_{GE(th)}$	$V_{GE}=V_{CE}, I_C=2.6mA$	5.35	6.0	6.7	V
Collector-Emitter Saturation Voltage	$V_{CE(sat)}$	$V_{GE}=15V, I_C=33A$ $T_j=25^\circ\text{C}$, $T_j=125^\circ\text{C}$ $T_j=150^\circ\text{C}$		1.35 1.48 1.55	1.65	V
		$V_{GE}=15V, I_C=80A$ $T_j=25^\circ\text{C}$, $T_j=125^\circ\text{C}$ $T_j=150^\circ\text{C}$		1.75 2.15 2.25	2.30	V
Zero Gate Voltage Collector Current	I_{CES}	$V_{CE}=1200V, V_{GE}=0V$ $T_j=25^\circ\text{C}$, $T_j=150^\circ\text{C}$			0.25 1.00	mA
Gate-Emitter Leakage Current	I_{GES}	$V_{CE}=0V, V_{GE}=\pm 20V$			± 100	nA

Parameter	Symbol	Conditions	Min.	Typ.	Max.	Unit
Dynamic						
Input Capacitance	C_{ies}	$V_{CE}=25V, V_{GE}=0V,$ $f=1MHz$	-	7.94	-	nF
Reverse Transfer Capacitance	C_{res}		-	0.19	-	
Gate Charge	Q_G	$V_{CC}=960V, I_C=80A,$ $V_{GE}=15V$	-	0.65	-	uC



Switching Characteristic, Inductive Load

Parameter	Symbol	Conditions	Min.	Typ.	Max.	Unit
Dynamic , at T_j= 25°C						
Turn-on Delay Time	t _{d(on)}	V _{CC} = 600V, I _C =80A, V _{GE} = -5V~15V, R _g =10Ω	-	33	-	ns
Rise Time	t _r		-	85	-	ns
Turn-on Energy	E _{on}		-	7.5	-	mJ
Turn-off Delay Time	t _{d(off)}		-	231	-	ns
Fall Time	t _f		-	174	-	ns
Turn-off Energy	E _{off}		-	4.6	-	mJ
Dynamic , at T_j= 125°C						
Turn-on Delay Time	t _{d(on)}	V _{CC} = 600V, I _C =80A, V _{GE} = -5V~15V, R _g =10Ω	-	30	-	ns
Rise Time	t _r		-	79	-	ns
Turn-on Energy	E _{on}		-	7.8	-	mJ
Turn-off Delay Time	t _{d(off)}		-	243	-	ns
Fall Time	t _f		-	263	-	ns
Turn-off Energy	E _{off}		-	5.5	-	mJ
Dynamic , at T_j= 150°C						
Turn-on Delay Time	t _{d(on)}	V _{CC} = 600V, I _C =80A, V _{GE} = -5V~15V, R _g =10Ω	-	28	-	ns
Rise Time	t _r		-	74	-	ns
Turn-on Energy	E _{on}		-	8.0	-	mJ
Turn-off Delay Time	t _{d(off)}		-	252	-	ns
Fall Time	t _f		-	325	-	ns
Turn-off Energy	E _{off}		-	6.2	-	mJ

Thermal Resistance

Parameter	Symbol	Max. Value	Unit
IGBT Thermal Resistance, Junction - Case	R _{th(j-c)}	0.17	K/W
Thermal Resistance, Junction - Ambient	R _{th(j-a)}	62	K/W

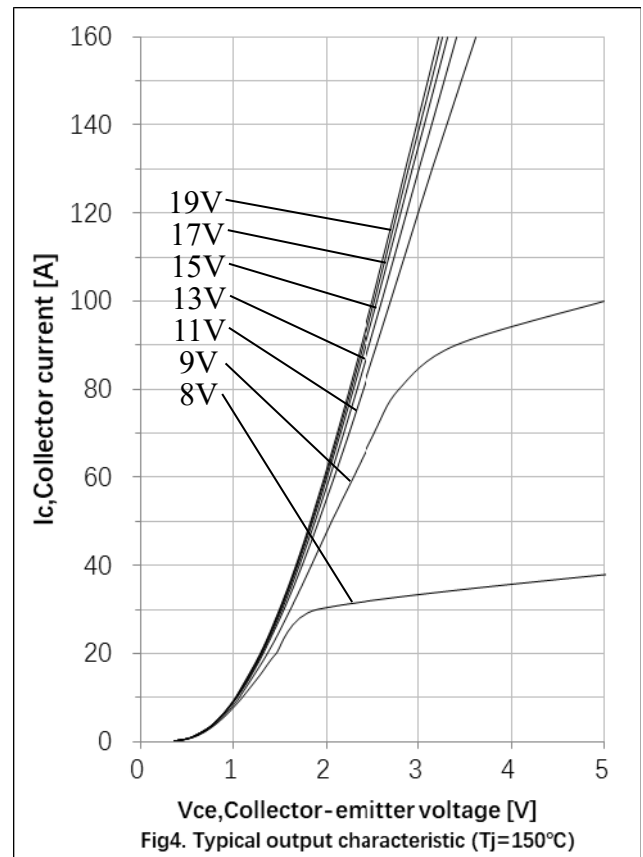
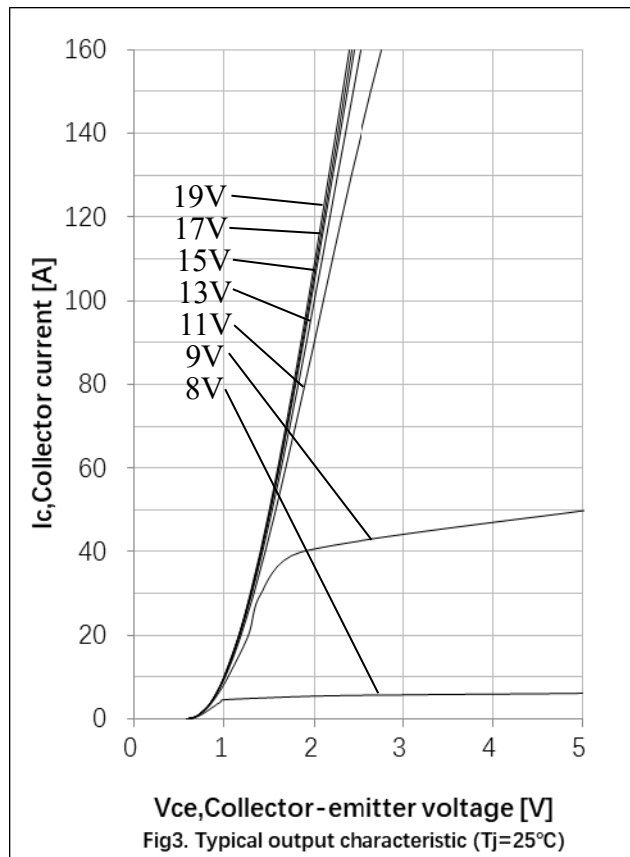
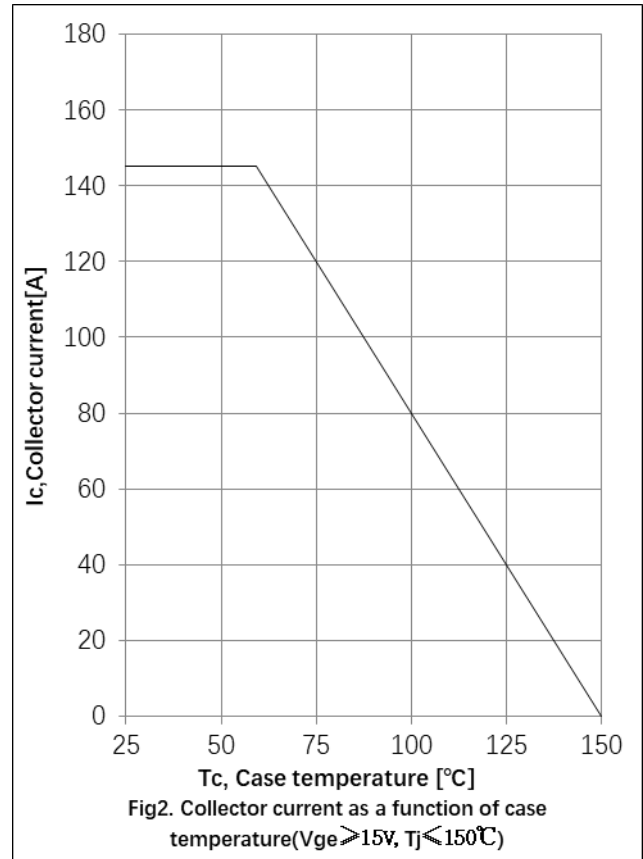
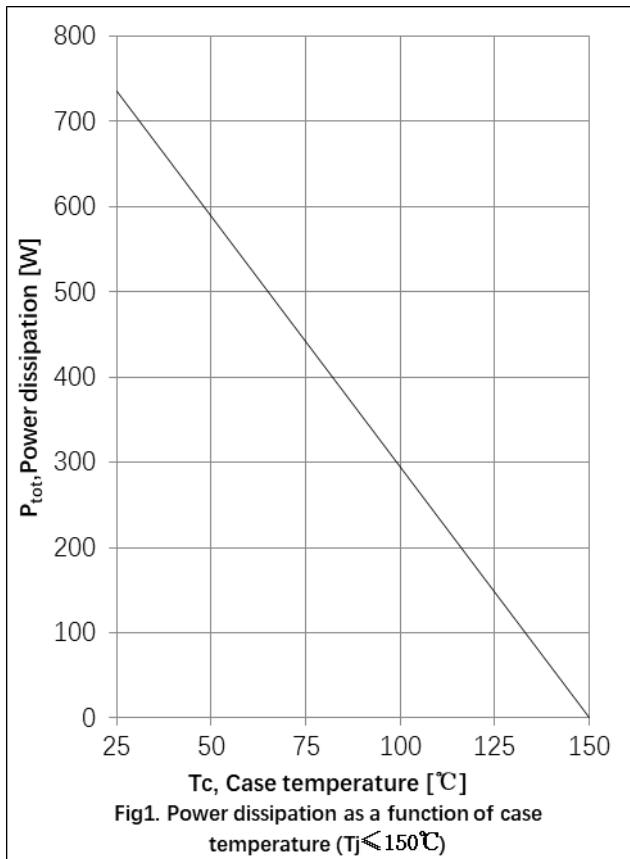

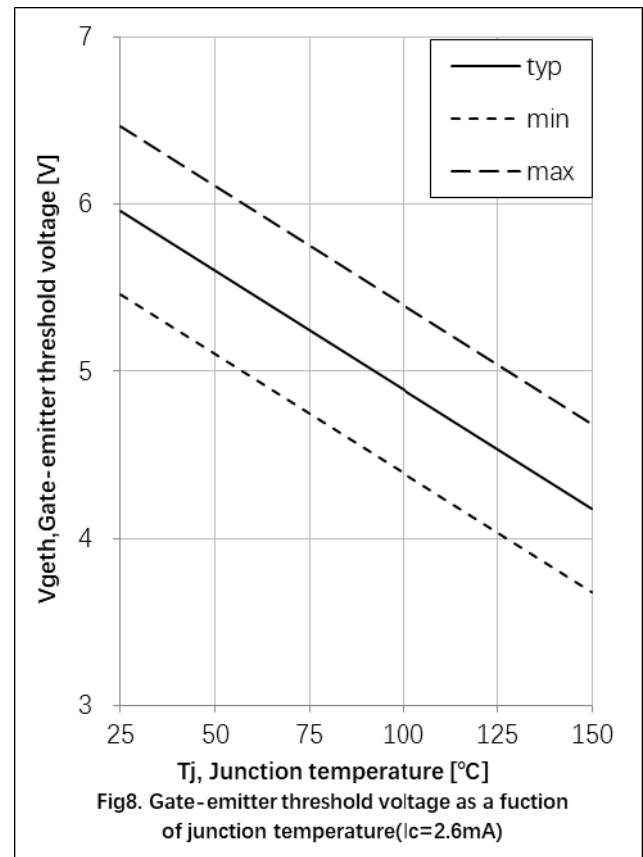
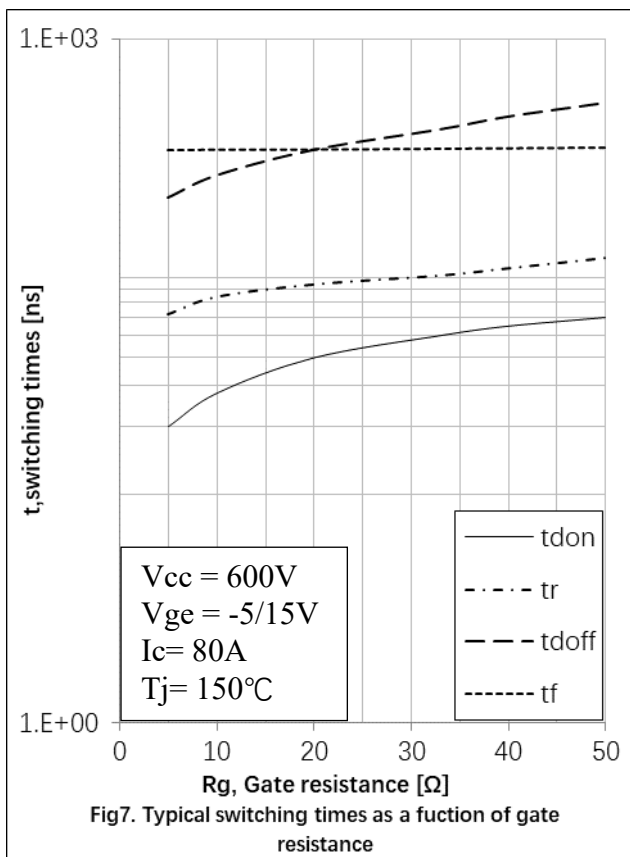
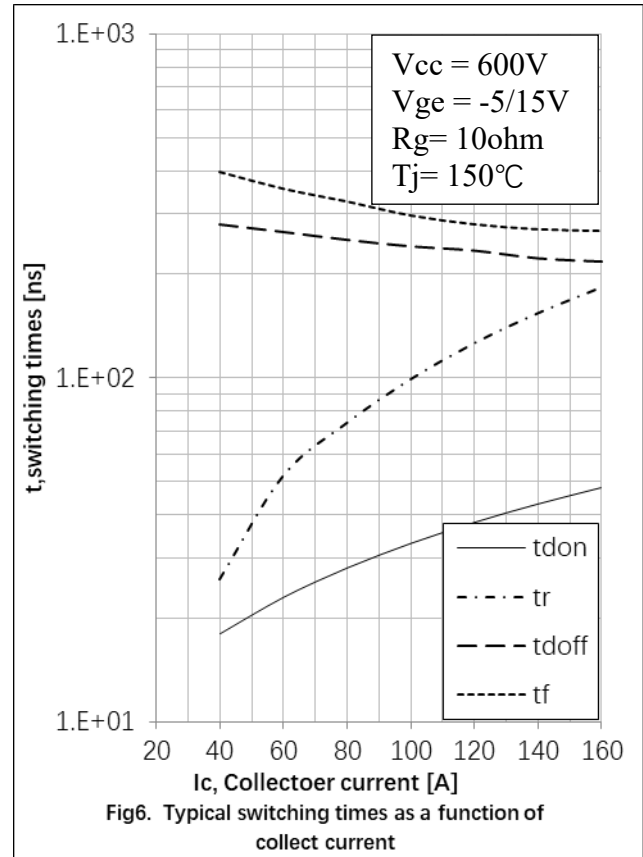
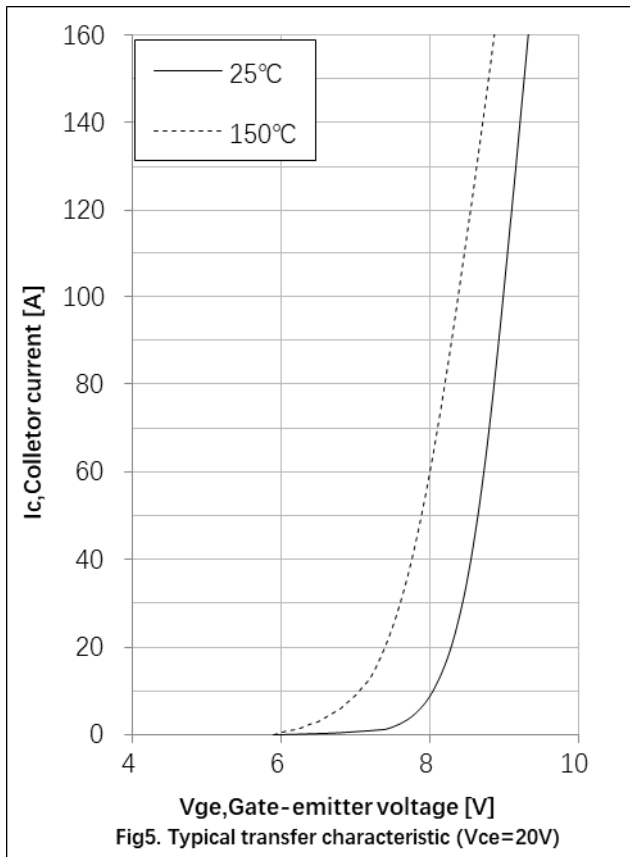

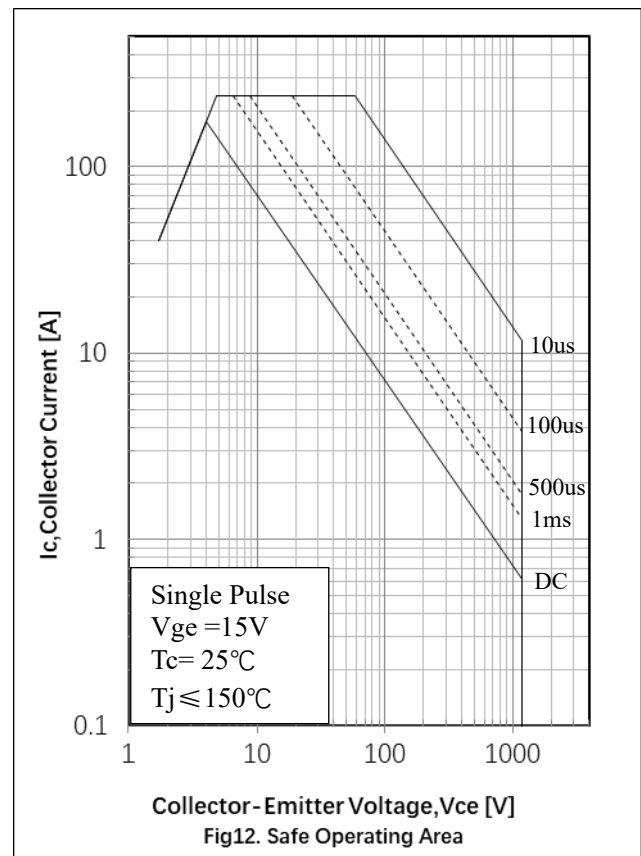
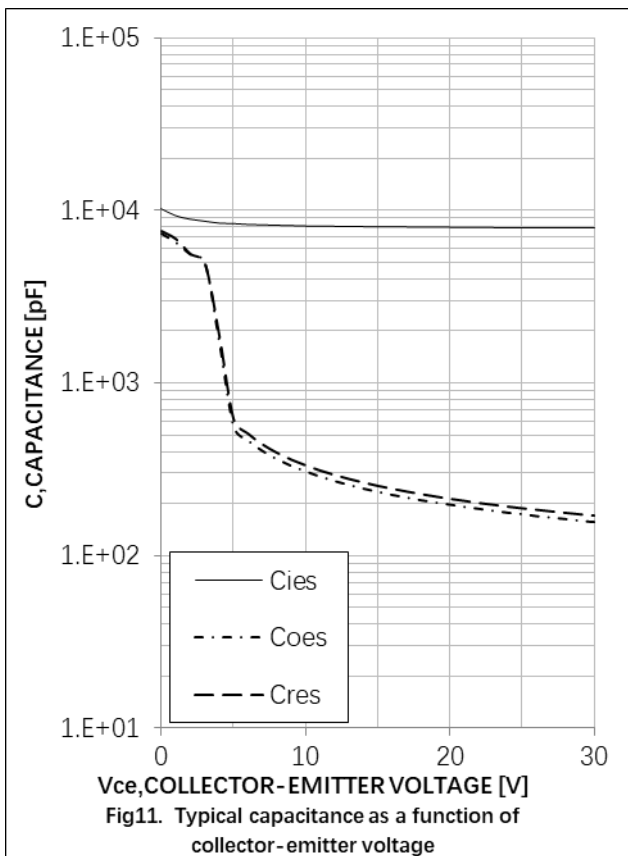
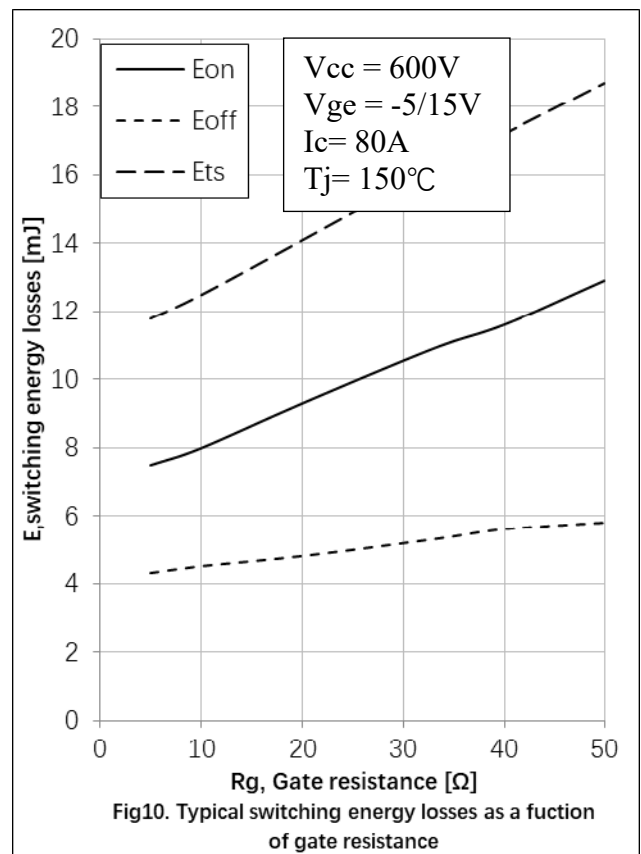
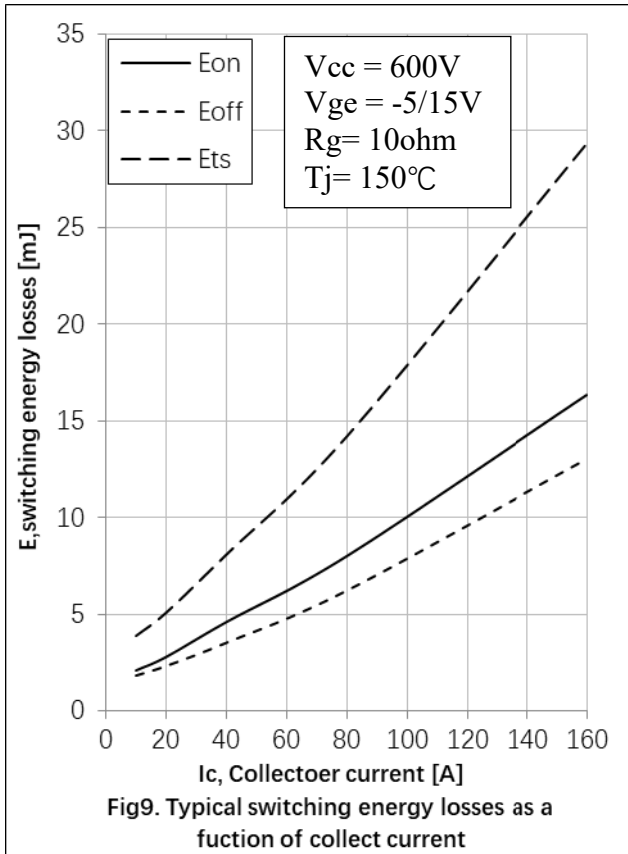

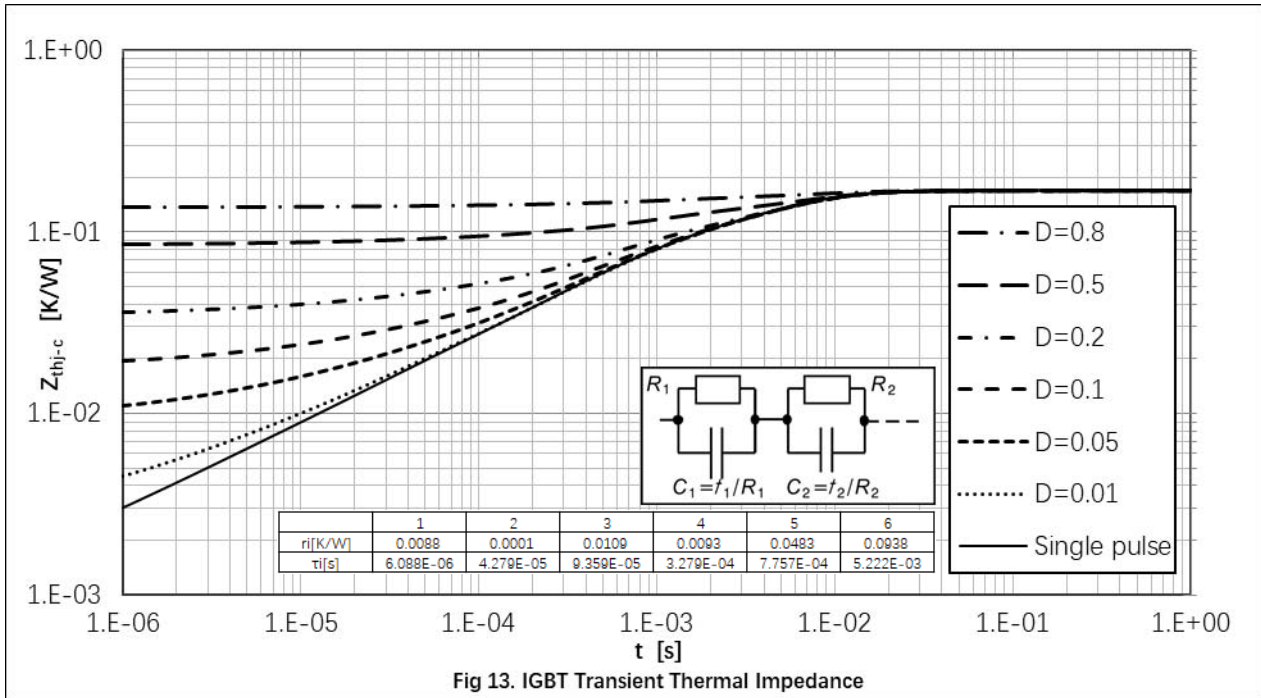

Circuit Diagram

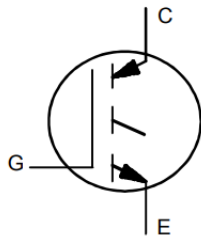

● Package Outline Information

CASE: STO 263

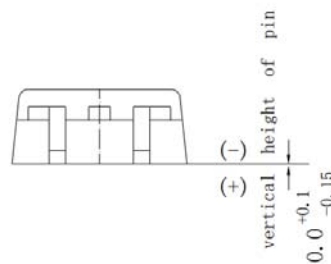
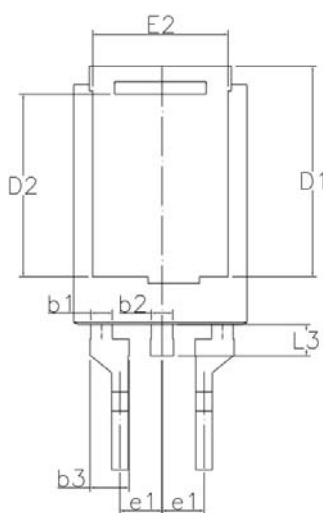
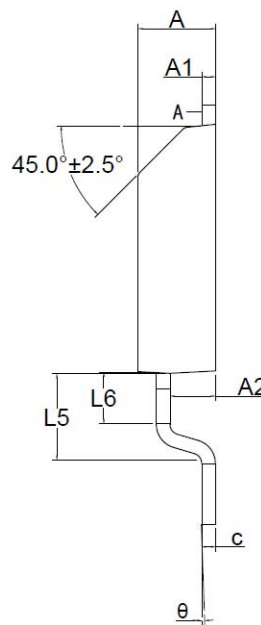
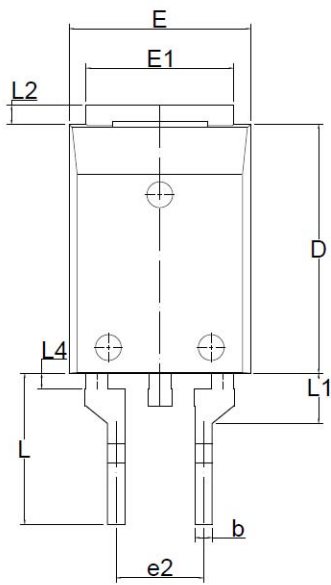

DIMENSIONS		
SYMBOL	Millimeter	
A	4.34	4.74
A1	0.70	1.00
A2	2.50	3.00
b	0.70	1.30
b1	1.25	1.65
b2	1.25	1.65
b3	2.16	2.36
c	0.70	1.00
D	14.00	15.00
D1	12.50	13.50
D2	10.54	11.54
E	10.00	11.00
E1	8.00	9.00
E2	7.70	8.70
e1	2.55 BSC	
e2	4.90	5.30
L	8.50	8.90
L1	2.65	3.15
L2	0.50	1.50
L3	1.40	2.40
L4	—	1.50
L5	5.05	5.45
L6	2.97 BSC	
θ	-2°	2°

Marking Information

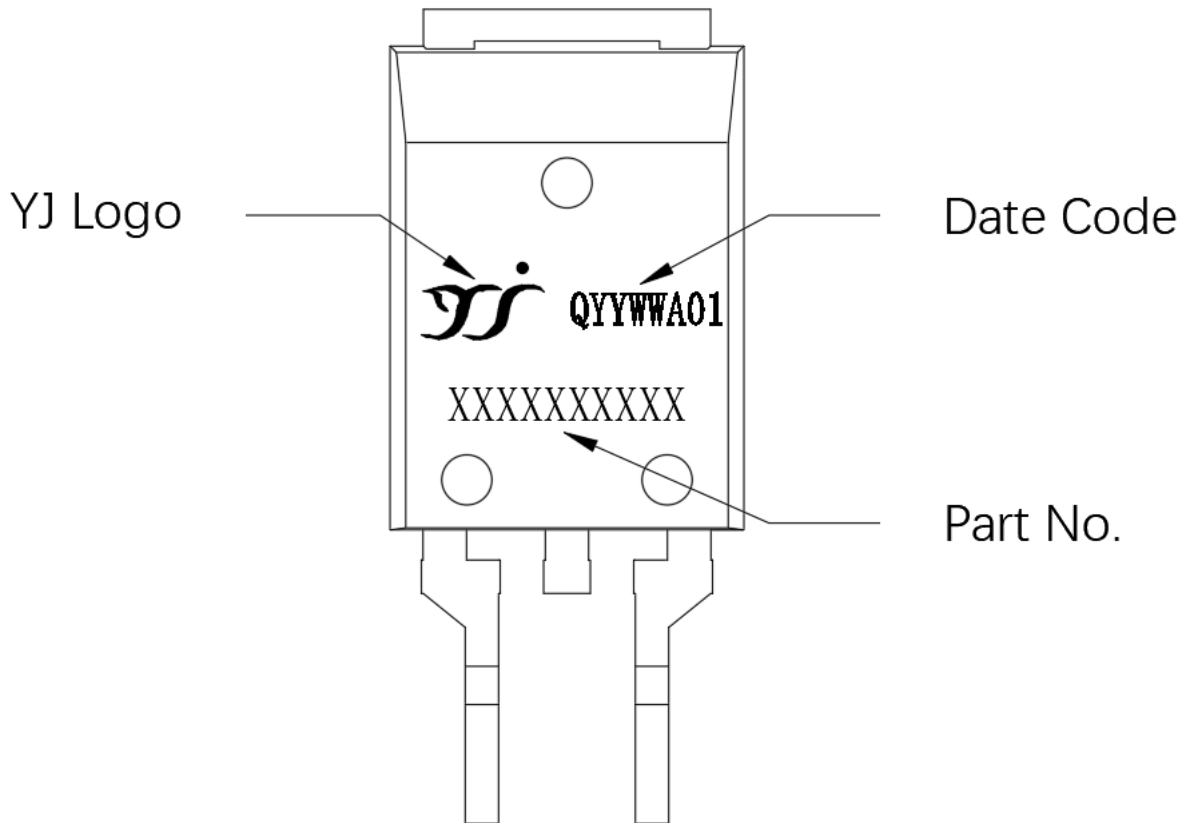

Package Parameters

Base Part Number	Package Type	Standard Pack		Orderable Part Number
		Form	Quantity	
DGR80N120ATL1BQ	STO-263	Reel	800	DGR80N120ATL1BQ

