

## NPN Plastic-Encapsulate Transistors

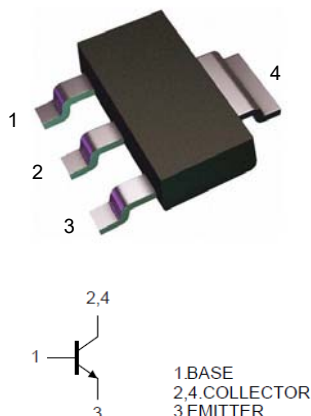

### SOT-223

#### Features

- Epoxy meets UL-94 V-0 flammability rating and halogen free
- Moisture Sensitivity Level 1
- Halogen Free.
- Part no. with suffix "Q" means AEC-Q101 qualified

#### Applications

- Linear voltage regulators
- Low-side switches
- Battery-driven devices
- MOSFET drivers
- Amplifiers

#### Mechanical Data

- Case: SOT-223
- Terminals: Tin plated leads, solderable per J-STD-002 and JESD22-B102
- Marking: BCP56-16.

#### ■ Maximum Ratings (Ta= 25°C unless otherwise noted)

Item	Symbol	Unit	Value
Collector-Base Voltage	$V_{CBO}$	V	100
Collector-Emitter Voltage	$V_{CEO}$	V	80
Emitter-Base Voltage	$V_{EBO}$	V	5
Collector Current -Continuous	$I_C$	A	1
Total Device Dissipation (*)	$P_D$	W	1.5
Thermal Resistance From Junction To Ambient (*)	$R_{\theta JA}$	°C/W	83.3
Thermal Resistance From Junction To Solder Point (*)	$R_{\theta Js}$	°C/W	16
Junction Temperature	$T_j$	°C	-55 to +150
Storage Temperature	$T_{STG}$	°C	-55 to +150

(\*) Device mounted on FR-4 PCB 1.575 x 1.575 x 0.0625 inch; mounting pad for collector =0.93 sq in



# BCP56-16Q

## ■ Electrical Characteristics (Ta= 25°C unless otherwise noted)

Item	Symbol	Unit	Conditions	Min	Typ	Max
Collector-base breakdown voltage	$V_{CBO}$	V	$I_C = 100\mu A, I_E = 0$	100		
Collector-emitter breakdown voltage	$V_{CEO}$	V	$I_C = 10mA, I_B = 0$	80		
Emitter-base breakdown voltage	$V_{EBO}$	V	$I_E = 10\mu A, I_C = 0$	5		
Collector-base cut-off current	$I_{CBO}$	$\mu A$	$V_{CB} = 30V, I_E = 0$			0.1
DC current gain	$h_{FE}$		$V_{CE} = 2V, I_C = 5mA$	25		
	$h_{FE}$		$V_{CE} = 2V, I_C = 150mA$	100		250
	$h_{FE}$		$V_{CE} = 2V, I_C = 500mA$	25		
Collector-emitter saturation voltage	$V_{CE(sat)}$	V	$I_C = 500mA, I_B = 50mA$			0.5
Base-emitter voltage	$V_{BE}$	V	$V_{CE} = 2V, I_C = 500mA$			1.0

## ■ Other Characteristics (Ta= 25°C unless otherwise noted)

Item	Symbol	Unit	Conditions	Min	Typ	Max
Transition frequency	$f_T$	MHz	$V_{CE} = 10V, I_C = 50mA, f = 100MHz$	100		

## ■ Ordering Information (Example)

PREFERRED P/N	PACKING CODE	UNIT WEIGHT(g)	MINIMUM PACKAGE(pcs)	INNER BOX QUANTITY(pcs)	OUTER CARTON QUANTITY(pcs)	DELIVERY MODE
BCP56-16Q	F2	Approximate 0.1	2500	5000	25000	13" reel

## ■ Characteristics(Typical)

Fig.1 - Collector Saturation Region

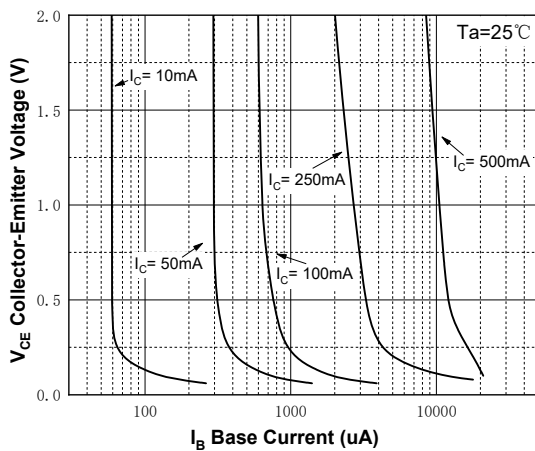

Fig.2 - DC Current Gain

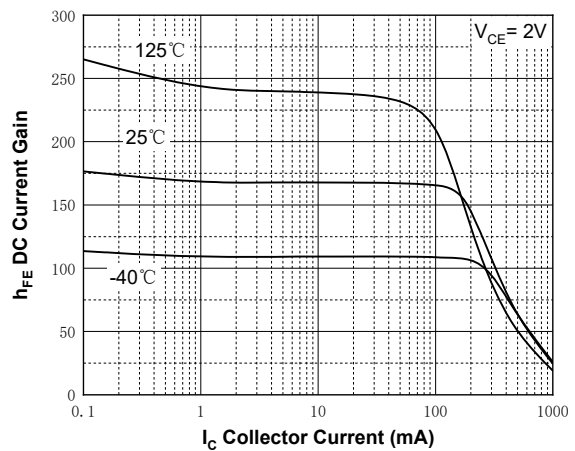



Fig.3 - Collector-Emitter Saturation Voltage vs. Collector Current

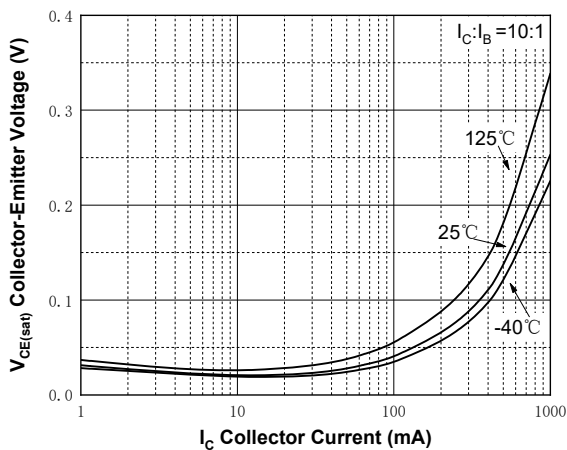

Fig.4 - Base-Emitter Saturation Voltage vs. Collector Current

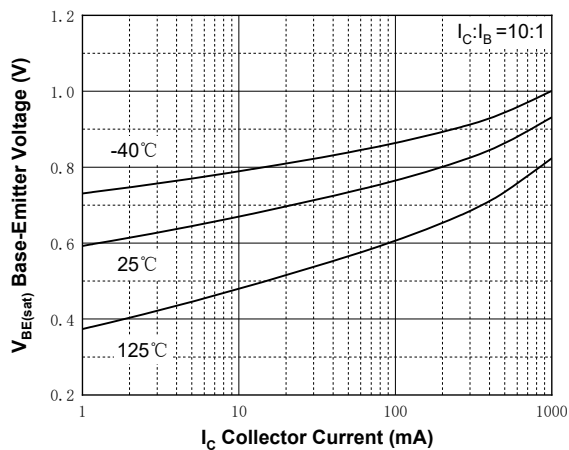

Fig.5 - Capacitance

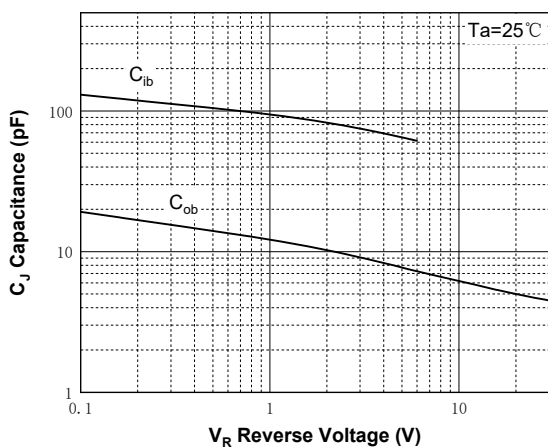
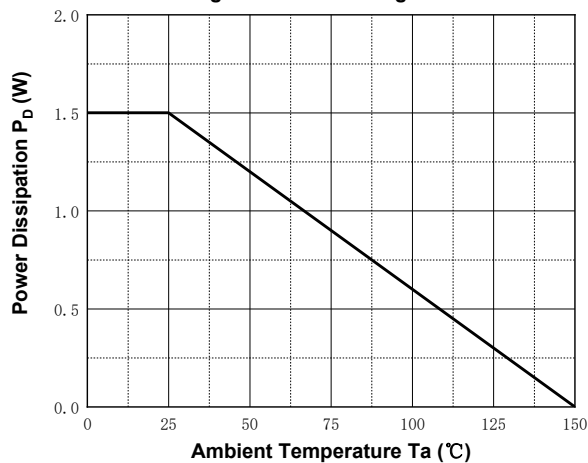

Fig.6 - Power Derating Curve





# BCP56-16Q

## ■ SOT-223 Package Outline Dimensions

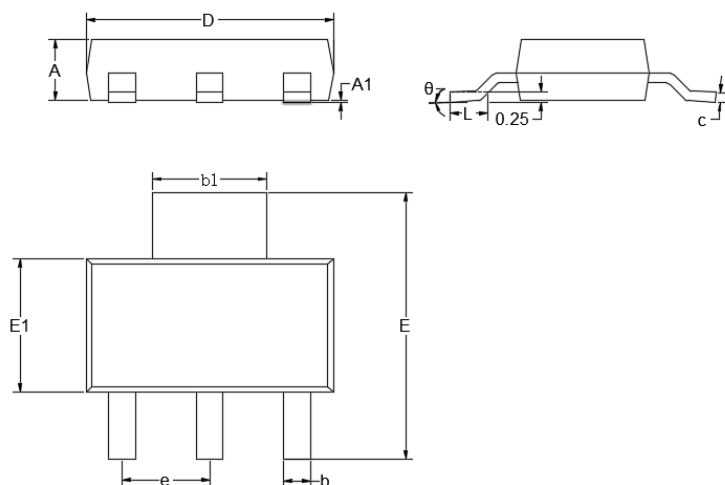

DIM	DIMENSIONS			
	INCHES		MM	
	MIN	MAX	MIN	MAX
A	0.0591	0.0670	1.5000	1.7000
A1	0.0008	0.0039	0.0200	0.1000
b	0.0259	0.0330	0.6600	0.8400
b1	0.1140	0.1220	2.9000	3.1000
c	0.0090	0.0138	0.2300	0.3500
D	0.2480	0.2640	6.3000	6.7000
E	0.2637	0.2874	6.7000	7.3000
E1	0.1290	0.1460	3.3000	3.7000
e	0.0866	0.0945	2.2000	2.4000
L	0.0295	0.0492	0.7500	1.2500
θ	0°	10°	0°	10°

## ■ SOT-223 Suggested Pad Layout

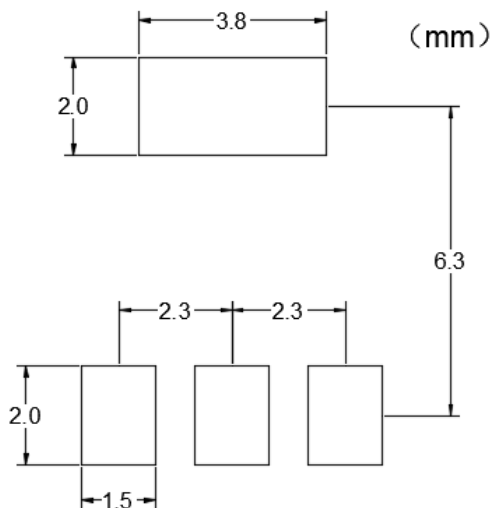



## BCP56-16Q

---

### Disclaimer

The information presented in this document is for reference only. Yangzhou Yangjie Electronic Technology Co., Ltd. reserves the right to make changes without notice for the specification of the products displayed herein to improve reliability, function or design or otherwise.

The product listed herein is designed to be used with automotive electronics, are not designed for use in medical, life-saving, life-sustaining, or military, Yangjie or anyone on its behalf, assumes no responsibility or liability for any damages resulting from such improper use of sale.

This publication supersedes & replaces all information previously supplied. For additional information, please visit our website [http:// www.21yangjie.com](http://www.21yangjie.com) , or consult your nearest Yangjie's sales office for further assistance.