

Switching Diode

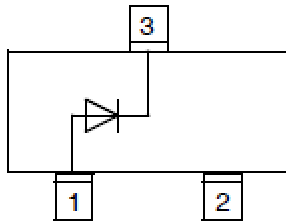

SOT-23

Features

- Epoxy meets UL-94 V-0 flammability rating and halogen free
- Moisture Sensitivity Level 1
- Low Current Leakage
- Part no. with suffix "Q" means AEC-Q101 qualified

Applications

- For General Purpose Switching Applications
- Automotive

Mechanical Data

- **Case:** SOT-23
- **Terminals:** Tin plated leads, solderable per J-STD-002 and JESD22-B102
- **Marking:** JS

■Maximum Rating (Ta=25°C Unless otherwise specified)

Item	Symbol	Unit	Value
Reverse Voltage	V_R	V	250
Forward Continuous Current, Per Leg	I_F	mA	200
Non-Repetitive Peak Forward Surge Current@ t=1s,	I_{FSM}	A	0.5
Power Dissipation	P_D	mW	350
Operation Junction Temperature	T_J	°C	-55 to +150
Storage Temperature	T_{STG}	°C	-55 to +150

■Electrical Characteristics (Ta=25°C Unless otherwise specified, Per Leg)

Item	Symbol	Unit	Conditions	MIN	MAX
Reverse Voltage	V_R	V	$I_R=100\mu A$	250	
Maximum Instantaneous Forward Voltage	V_F	V	$I_{FM}=100mA, T_J=25^\circ C$		1.0
			$I_{FM}=200mA, T_J=25^\circ C$		1.25
Maximum DC Reverse Current	I_R	nA	$V_R=200V$		100
Typical Junction Capacitance	C_J	pF	f=1.0MHz, $V_R=0V$		5
Reverse Recovery Time	T_{rr}	ns	$I_F=30mA, I_R=30mA, R_L=100\Omega, I_{rr}=3mA$		50



BAS21Q

■ Thermal Characteristics (Ta=25°C Unless otherwise specified)

PARAMETER	SYMBOL	UNIT	Value
Thermal Resistance(Typical)	$R_{\theta JA}$	°C/W	357

■ Ordering Information (Example)

PREFERRED P/N	PACKING CODE	UNIT WEIGHT(g)	MINIMUM PACKAGE(pcs)	INNER BOX QUANTITY(pcs)	OUTER CARTON QUANTITY(pcs)	DELIVERY MODE
BAS21Q	F2	Approximate 0.010	3000	30000	120000	7" reel

■ Typical Characteristics (Per Leg)

Fig.1: P_D-T_A

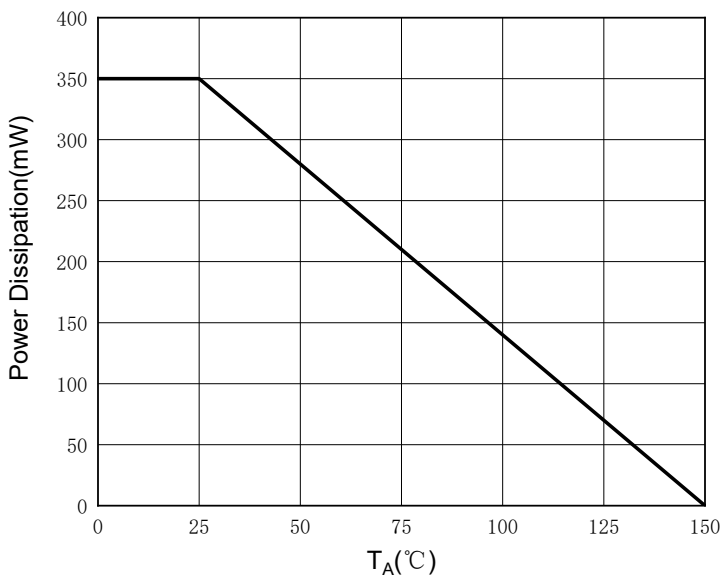

Fig.2: Forward Characteristics

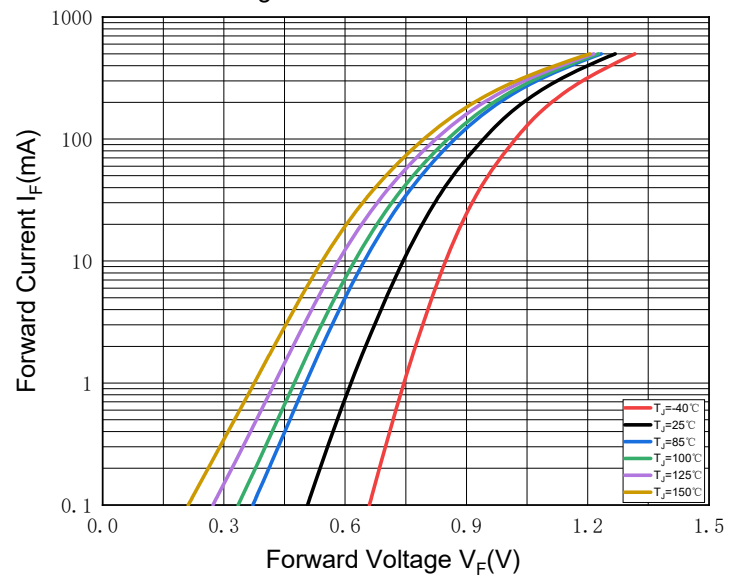

Fig.3: Reverse Characteristics

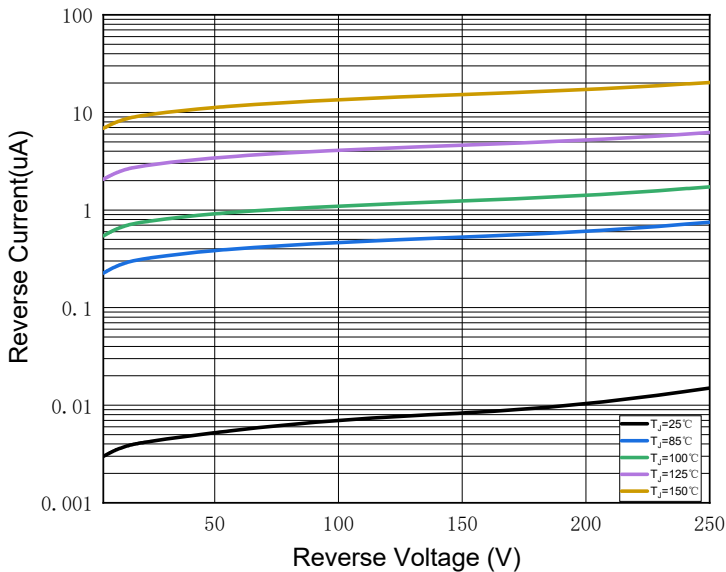
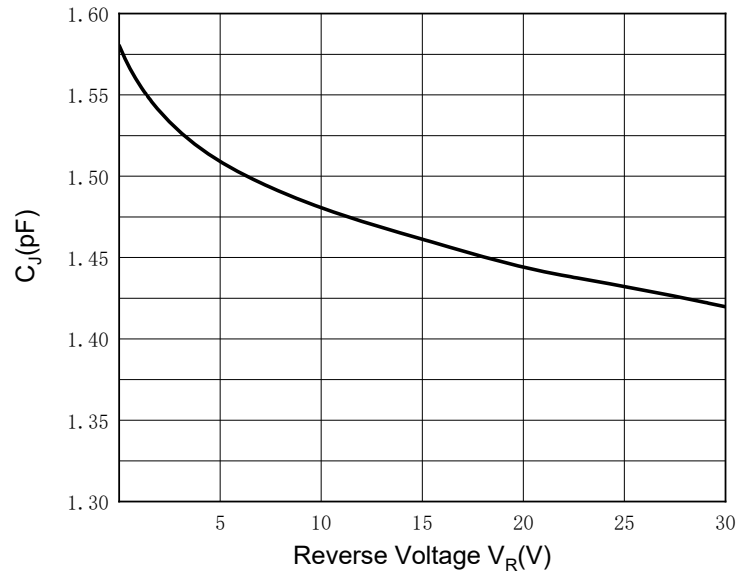

Fig.4: Capacitance Characteristics





BAS21Q

■ SOT-23 Package Outline Dimensions

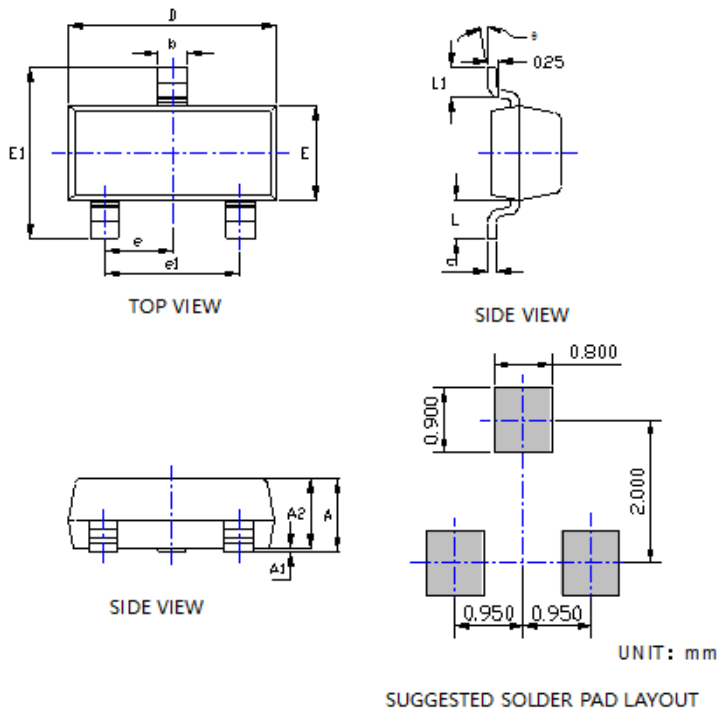

SYMBOL	DIMENSIONS			
	INCHES		Millimeter	
	MIN.	MAX.	MIN.	MAX.
A	0.035	0.045	0.900	1.150
A1	0.000	0.004	0.000	0.100
A2	0.035	0.041	0.900	1.050
b	0.012	0.020	0.300	0.500
c	0.004	0.008	0.100	0.200
D	0.110	0.118	2.800	3.000
E	0.047	0.055	1.200	1.400
E1	0.089	0.100	2.250	2.550
e	0.037TYP		0.950TYP	
e1	0.071	0.079	1.800	2.000
L	0.022REF		0.550REF	
L1	0.012	0.020	0.300	0.500
θ	0°	8°	0°	8°

NOTE:
 1. PACKAGE BODY SIZES EXCLUDE MOLD FLASH AND GATE BURRS.
 2. TOLERANCE 0.1mm UNLESS OTHERWISE SPECIFIED.
 3. THE PAD LAYOUT IS FOR REFERENCE PURPOSES ONLY.

■ Marking Information

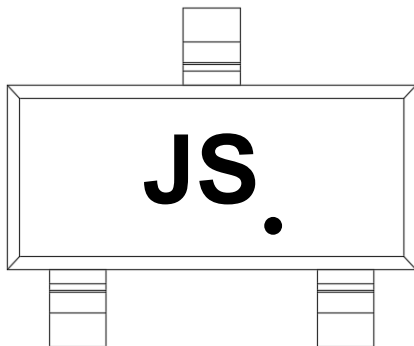

Note:

1. All marking is at middle of the product body
2. All marking is in laser marking
3. Body color: Black



BAS21Q

Disclaimer

The information presented in this document is for reference only. Yangzhou Yangjie Electronic Technology Co., Ltd. reserves the right to make changes without notice for the specification of the products displayed herein to improve reliability, function or design or otherwise.

The product listed herein is designed to be used with automotive electronics, are not designed for use in medical, life-saving, life-sustaining, or military, Yangjie or anyone on its behalf, assumes no responsibility or liability for any damages resulting from such improper use of sale.

This publication supersedes & replaces all information previously supplied. For additional information, please visit our website [http:// www.21yangjie.com](http://www.21yangjie.com) , or consult your nearest Yangjie's sales office for further assistance.